

PERFORMANCE SERIES

H4W2PER2V



Network WDR 2MP IR Rugged Mini Dome Camera







OPERATIONAL	
VIDEO STANDARD	NTSC / PAL
SCANNING SYSTEM	Progressive scan
IMAGE SENSOR	12.8" 2 Megapixel progressive CMOS
NUMBER OF PIXELS (H x V)	1920(H) x 1080(V)
MINIMUM ILLUMINATION	0.002ux / F1.5 (color, 30IRE), 0Lux / F1.5 (IR on)
S/N RATIO	More than 45dB
ELECTRONIC SHUTTER SPEED	1 / 3 ~ 1 / 100000s
IR DISTANCE	Up to 40m(131ft), depending on scene reflectance
IR LIGHT CONTROL	Manual / SmartIR / OFF
IR LIGHT NUMBER	2
DAY/NIGHT	Auto(ICR) / Color / B&W
BACKLIGHT COMPENSATION	BLC / HLC / WDR
WHITE BALANCE	Auto / Natural / Street Lamp / Outdoor / Manual / Customized Region
GAIN CONTROL	0~100
WIDE DYNAMIC RANGE	120 dB
NOISE REDUCTION	3D DNR
PRIVACY MASKING	Off / On (4 Areas, Rectangle)
MOTION DETECTION	Off / On (4 Zones, Rectangle)
REGION OF INTEREST	Off / On (4 Zones)
LENS	2.7mm~13.5mm, Motorized, F1.5
ANGLE OF VIEW	H:109°~28°, V:57°~16°
VIDEO	
VIDEO COMPRESSION	H.265 / H.264 B / Smart Codec / MJPEG (Sub Stream)
RESOLUTION	1080p (1920 x 1080); 1.3M (1280 x 960); 720p (1280 x 720); D1 (704 x 576 / 704 x 480); VGA (640 x 480); CIF (352 x 288 / 352 x 240)
FRAME RATE	Main Stream: 1920 x 1080 / 1280 x 960 / 1280 x 720@ (1 ~ 25 / 30fps) Sub Stream: 704 x 576 / 640 x 480 / 352 x 288 @ (1 ~ 25fps); 704 x 480 / 640 x 480 / 352 x 240 @ (1 ~ 30fps)
BIT RATE CONTROL	CBR / VBR
BIT RATE	H.264: 32 kbps~6144 kbps H.265: 12 kbps~6144 kbps
INTERFACE	
ETHERNET	RJ-45 (10 / 100 Base-T)
AUDIO	1 In; 1 Out
ALARM input/output	1 In; 1 Out



NETWORK (CONT'D)	
PROTOCOLS*	HTTP; HTTPS; TCP; ARP; RTSP; RTP; RTCP; UDP; SMTP; DHCP; DNS; PPPoE; IPv4 / v6; QoS; UPnP; NTP; Bonjour; IEEE 802.1x; Multicast; ICMP; IGMP; TLS
INTEROPERABILITY	ONVIF Profile S / G / Q
MAXIMUM USERS ACCESS	20 Users
SECURITY	User account and password protection HTTPS, IP Filter, Digest authentication, User access log, TLS1.2 only, AES-128 / 256, SSH / Telnet closed, sFTP by default, PCIDSS compliance
EVENT	No SD card, SD card error, Capacity warning, Network disconnection, IP conflict, Illegal access
MICRO SD	Up to 128 GB microSDHC card, Class 10 (not included)
ANALYTICS	
VIDEO ANALYTICS	Motion Detection, Video Tampering, Scene Changing, Tripwire Intrusion
ELECTRICAL	
POWER SUPPLY	DC12V, PoE (802.3af)(Class 0)
POWER CONSUMPTION	<6.4W
MECHANICAL	
DIMENSIONS	Ø122mm x 88.9mm (4.80"x3.50")
PRODUCT WEIGHT	0.50kg (1.10lb)
PACKAGE WEIGHT	0.66kg (1.46lb)
CONSTRUCTION	Die-cast aluminum housing with powder coat
CONSTRUCTION COLOR	RAL 9003 (White)
ENVIRONMENTAL	
OPERATING TEMPERATURE	-30° C ~ 60° C (-22° F ~ 140° F)
RELATIVE HUMIDITY	Less than 95%, non-condensing IP
INGRESS PROTECTION	IP66
VANDAL RESISTANCE	IK10
REGULATORY	
EMISSIONS	FCC Part 15B, EN 55032
IMMUNITY	EN 50130-4
SAFETY	UL 60950-1, EN 62368-1
ROHS	EN 50581

* Some development may be required in specific user cases to support some of these protocols in the field as they mature over time.

Network WDR 2MP IR Rugged Mini Dome Camera

RECOMMENDED ACCESSORIES

SYSTEM COMPATIBILITY		MOUNTS AND ACCESSORIES	
HEN*4	8 / 16 / 32 / 64-channel Performance Series 4K NVRs (H.264 and H.265)	HQA-PM2**	 Pole Mount Adapter
HEN*3	4 / 8 / 16 / 32-channel Performance Series 4K NVRs (H.264 and H.265)	HQA-IC	 In-Ceiling Bracket
		HQA-BB4**	 Junction Box
		HQA-CB**	 Ceiling Mount Bracket for Pendant Mount Cap
		HQA-CBE**	 Ceiling Mount Extend Bracket for HQA-CB

MOUNTS AND ACCESSORIES		
HQA-RS		Rain Shield Bracket
HQA-PK**		Pendant Mount Cap
HQA-WK		Wall Mount Bracket

** The HQA-BB4 must be used when installing the camera to HQA-PM2, vice versa.

The HQA-PK must be used when installing the camera to HQA-CB.

The HQA-CBE must be used with HQA-CB together.

ORDERING

H4W2PER2V	Network WDR 2MP IR Rugged Mini Dome Camera, 1 / 2.8" CMOS, 2.7mm~13.5mm Motorized, 2 IR LEDs, PoE, IP66, IK10, H.265 / H.264 / SmartCodec
-----------	---

DIMENSIONS

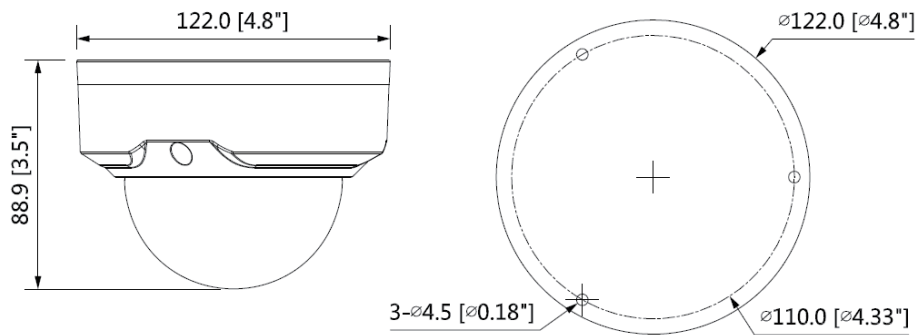

For more information, please contact:
buildings.asean@honeywell.com

Malaysia (ASEAN Headquarters)
Honeywell International Sdn. Bhd.
Level 25, UOA Corp Tower B, Avenue 10
The Vertical, Bangsar South City,
59200, Kuala Lumpur, Malaysia
www.honeywell.com

ONVIF and the ONVIF logo are trademarks of ONVIF Inc.
Honeywell reserves the right, without notification, to make changes in product design or specifications.

HSV-H4W2PER2V-01-US(0321)DS-Y
© 2021 Honeywell International Inc.

Honeywell